

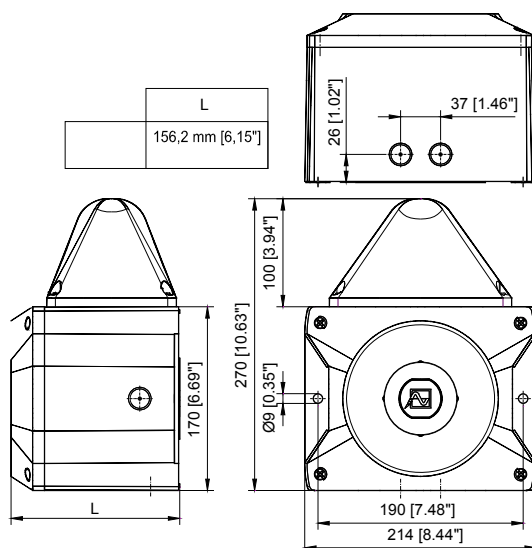

Operating and installation instruction



Nom. sound level	117dB (A) 1m					
Volume control	-10dB					
Tones	80					
Flash energy	10J					
Flash frequency	1Hz					
Rated voltage (limits see approvals)	12V DC	24V DC	48V DC	24V AC	115V AC	230V AC
Operating voltage range	10,5 – 15 V	18V – 30V	40V – 60V	20 – 30V	95V – 127V	195V – 253V
Current consumption Sounder (max.) [mA]	490	360	230	850	150	100
Current consumption Beacon (max.) [mA]	1400	680	300	1400	300	160
Power consumption	22 W	22 W	32 W	54,5 VA	34,5 VA	40,5 VA
Duty cycle	100%					
Connection terminal	0,14 - 2,5mm ² / AWG24 - AWG 14 (stranded)					
Ingress protection	IP66 (EN60529), Type 4 & 4x					
Resistance against impact	IK08 (EN50102)					
Protection class	II  Double insulated equipment					
Operating temperature	-40°C...+55°C					
Storage temperature	-40°C...+70°C					
Max. rel. Humidity	90%					
Cable entry	7x M20 (prepared)			5x M20 (prepared)		
Sealing range of grommet	7 – 13 mm					
Material of housing	With the use of cable diameters <7mm, a cable screw joint with sufficient ingress protection must be provided PC/ABS Blend					
Material of lens	PC					
Installation position	arbitrarily					
Options	-SSM, (see page 11)					
Accessory	Sealing plug (Art-no. 28300000002)					
Lens colours	- clear, white, yellow, amber, red, green, blue					

Approvals (valid for marked equipment)

Construction Product Regulation (305/2011/EC) 	110-230V AC:		24-48V DC:	
	VdS 0786-CPD- 21184		VdS 0786-CPD- 21223	
	Options			
	Rated voltage		24 – 48 V DC	
	Operating voltage range acc. to EN54-3, EN54-23		18V – 60V Option: -SSM (18V – 30V)	
	Tone		Compliant with the Construction Product Directive (89/106/EWG) 1200Hz-500Hz (Saw tooth) DIN/PFEER P.T.A.P. 500Hz-1200Hz (Slow whoop) 825Hz (Continuous) 660Hz (Intermittent tone) 800Hz/ 1000Hz (Alternating tone) 544Hz/ 440Hz (NF S 32-001)	
	2			
	15			
	60			
	104			
131				
146				
Signaling area		EN54-3: see documents 30305-005-1		
Environmental protection class		Type B		
Testing takes place using the supplied diaphragm nipple and the outer fastening bores.				
VdS	110 – 230V AC:		24 - 48V DC:	
	G212116		G212191	
	Data see Construction Product Regulation (305/2011/EC)			
GL	61062-13 HH Environmental Category C, H, EMC1			
MED	61739-14 HH			
UL, cUL		Rated voltage	Audible Signal Appliance Fire Alarm Equipment ULSZ, ULSZ7	Audible and Visual Signal Appliance General Signal Equipment UCST, UCST7 and UEES, UEES7
		24V – 48V DC (Fire Alarm Equipment) 12V – 48V DC (General Signal Equipment)	x Special application, limited operating voltage range 18 – 60V DC	x
		24V AC 110 – 240V AC	-	x
		115V AC 230V AC 24V AC 12V DC 24V DC 48V DC	-	x

PATROL sounders and combined units comply with the limits for a Class B digital device, pursuant to part 15 of the FCC Rules.

UL/ cUL specifications:

Inrush current	Surge Current Peak	Surge Current RMS (16,7ms frame)	Voltage
24 – 48 V DC	27 A	4,5 A	60 V DC
24 V AC	11,5 A	6,8 A	30 V AC
110 – 240 V AC	18,5 A	1,45 A	265 V AC

Suitable for indoor and outdoor use.
Signaling area: see document 30305-005-1

Cable gland entries:

Conduit installation needs to be UL/ cUL listed fittings suitable for knockout openings. The supply wiring has to be enclosed in metal conduits for products for Fire Alarm Use.

Installation:

The units shall be installed indoors or outdoors in accordance with the manufacturer's installation instructions as well as the National Electrical Code (NFPA 70) and the National Fire Alarm Code (NFPA 72) for the units evaluated for Public Fire Alarm applications in the U.S. In Canada, they shall be installed in accordance with the Canadian Electrical Code, Part 1 and the Standard for the Installation of Fire Alarm Systems CAN/ULC-S524-M91 for the units evaluated for Public Fire Alarm applications. The installation shall also be in a manner acceptable with the local authority having jurisdiction.

For audible application for Fire Alarm Service use both terminals for connection. Break wire run to provide Electrical Supervision (see UL 464 clause 39.1e). The tone no. 111 is to be used for evacuation use only (see UL 464 clause 39.1e)

Volume control:

cUL directional characteristics for the horn:

AXIS	LE	dB(A)
Horizontal	32 deg. left or right	-3
Horizontal	28 deg. left or right	-6
Vertical	32 deg. left or right	-3
Vertical	28 deg. left or right	-6

Min. Output sound pressure level: [dB(A)]

(Tone no. 2, 15, 60, 104, 131, 146, 111, 112, and 113 was used for this test.)

Type	Voltage	UL 464 db(A) at 10 ft ++	CAN/ULC-S525-07
24-48 DC	18V DC	82,4 (for tone 113)	92,4 (for tone 111)

Connecting cables:

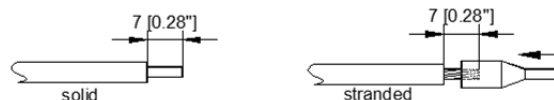

Taking into operation

Safety notes:

- Installation must be carried out by an electrician in compliance with the latest codes and regulations.
- Danger: High voltage may be present.
- Prior to opening, it must be ensured that no voltage is applied to the device.
- Before electrical connection, the supply voltage on the type plate is to be checked. The wrong operating voltage can lead to damages or to the destruction of the equipment.
- During installation it must be ensured that the connection cables are secured against tension and distortion. Please observe: The devices are not designed for portable use.
- CAUTION: When making installation, route field wiring away from sharp projections, corners and internal components.
- The opening of the bell mouth must not point upwards, especially in the case of use outdoors or in a particularly dusty environment.
- The function of the unit is only guaranteed if the upper and lower section is joined correctly.

When using the sounder –beacon combination :

- In order to prevent detriment to sight, continuously looking directly in the activated light is to be avoided.

Opening the housing:

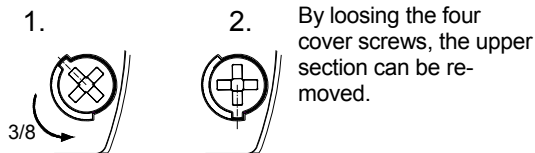

By loosening the four cover screws, the upper section can be removed.

Closing the housing

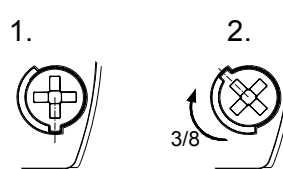

The housing is closed by turning the cover screws to the limit position until the housing locks into place.

The unit is not closed when delivered.

Sealing plugs for the housing screws are available as accessories.

Cable gland entries

To guarantee the specified protection type, cable grommets with a protection type of IP 66 are to be installed at the openings provided for this purpose. The supplied diaphragm nipple can be replaced with a cable gland or with an M12 plug connection with a flange measurement of M20.

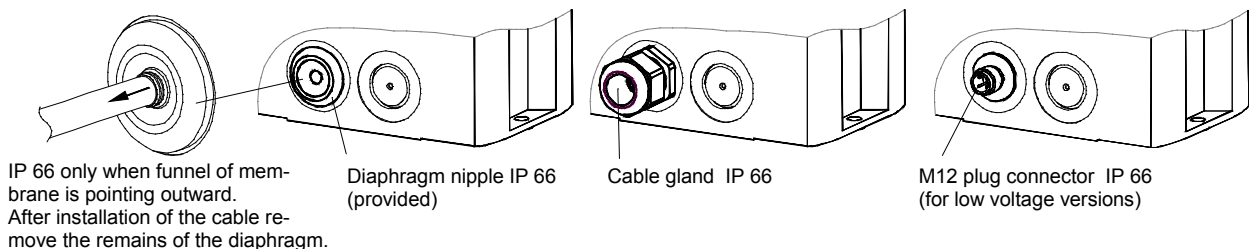

Circuit board for electrical connection (located in the base section):

Electrical connection and tone selection using external control C1 and C2

Terminal for operating voltage - Sounder:

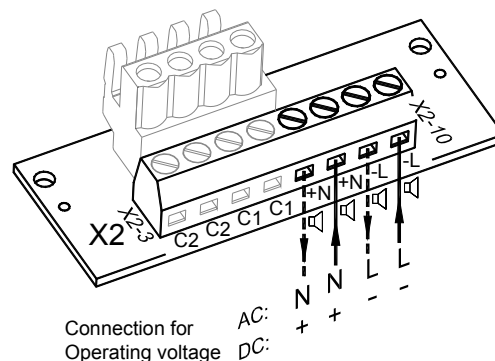

Terminal for operating voltage - Sounder-beacon combination:

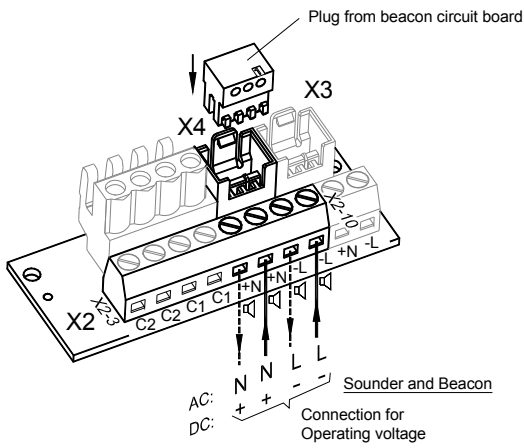

Common connection of beacon and sounder (Delivery status)

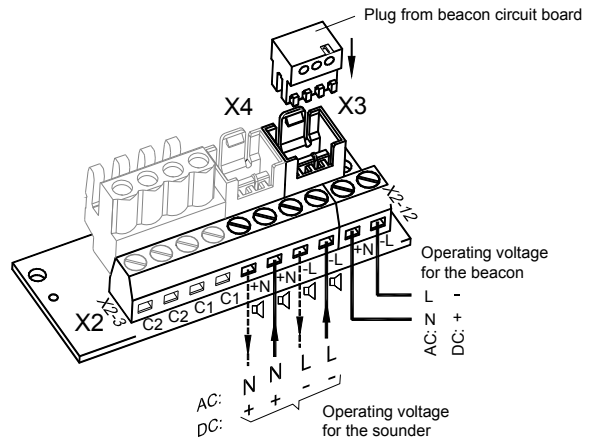

Separate connection of beacon and sounder

The desired tone can be selected using the tone selector switch S3 (on the driver circuit board). The available tones are described in the tone table in the appendix. After establishing the supply voltage the tone is generated.

Driver circuit board of sounder (located in the upper section):

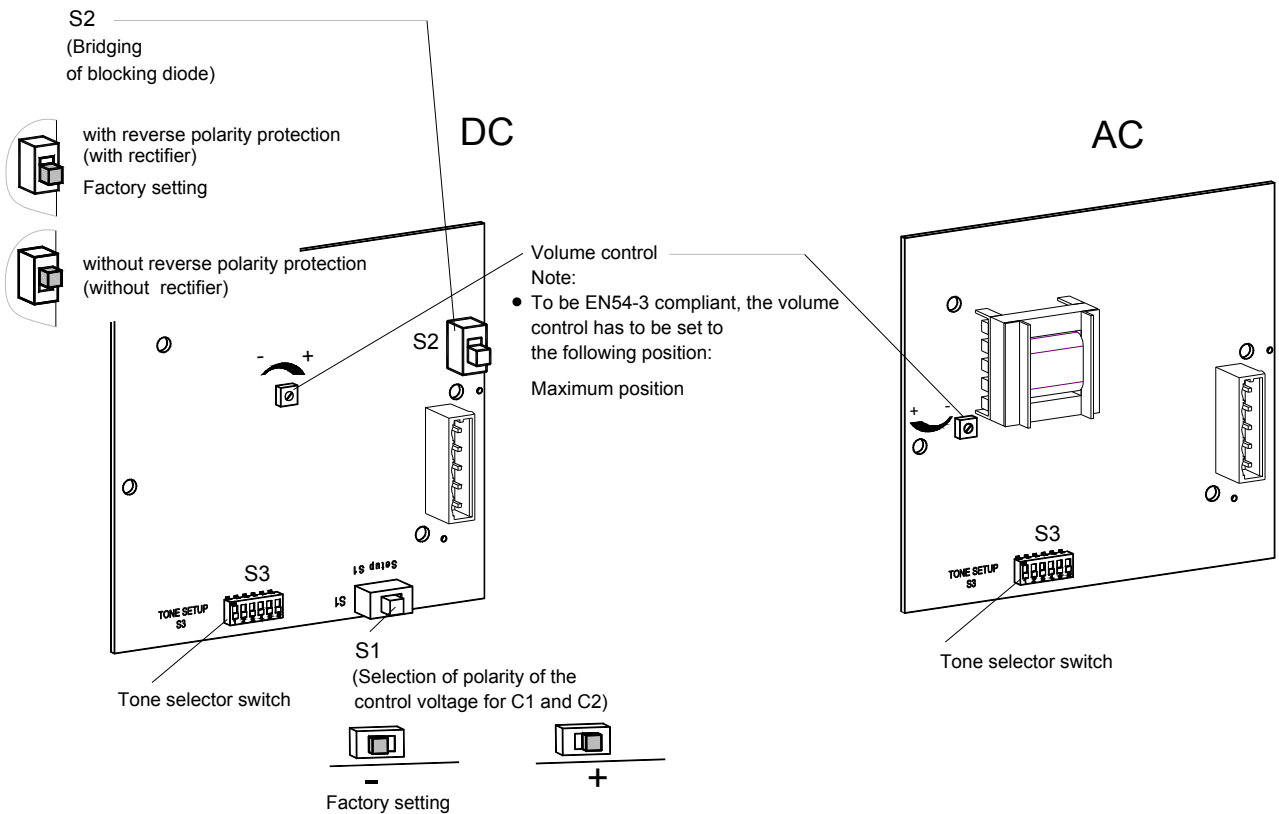

Change of the tones by external control

For applications which require more tones than just the base tone, it is possible to provide up to three additional tone types with the use of the following electrical controls.

As a basic rule, the desired base tone (J, see tone table in the appendix) is set with the tone selector switch S3 on the driver board. The corresponding additional tones (C1, C2, C1+C2) can be gathered from the table "Selection of the tones".

Tone selection with control input (TAS)

DC-Version:

When used with correct polarity, the tone selection takes place through the control inputs C1 and C2 on the circuit board. In the process, the supply voltage must always be applied together with the two control inputs. Setting of switch S2 in position "with rectifier"

= with reverse polarity protection.

The selection of the polarity of the control voltage ("+" or "-") takes place with the switch S1 on the driver board.

"+": positive control

"-": negative control (factory setting)

Caution: If the control voltage is greater than the supply voltage or the supply voltage is not applied, the operating current supply is provided through the control inputs. A corresponding load capacity must then be guaranteed.

AC-version:

In the AC version the tone selection takes place by connecting the phase "L" of the supply voltage to the control inputs C1 and C2. In the process, the supply voltage must always be applied together with the two control inputs.

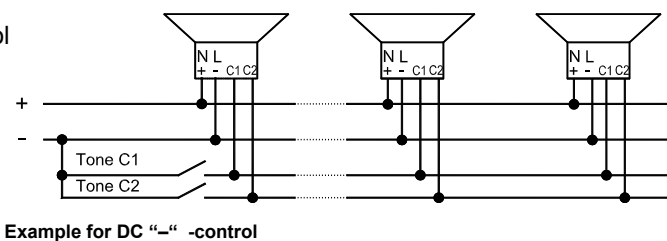
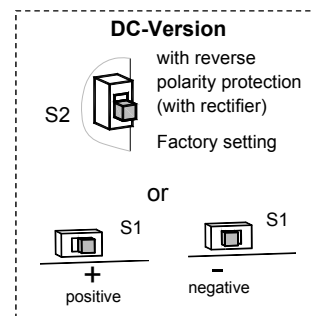
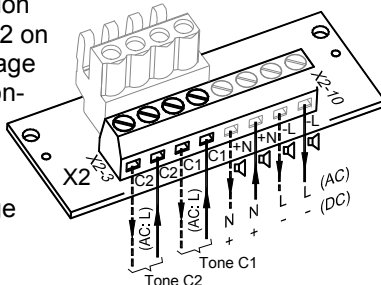

Example for DC "-" -control

Tone selection with supply through control input (TAV) - for all DC versions

The sounder can be supplied with operating voltage through the control inputs C1 and C2 on the circuit board. Supply and tone selection thus take place simultaneously.

The minus pole of the sounder must be connected. With connection of the positive voltage to the plus pole of the circuit board, the base tone (J) is generated; with connection to C1 or C2 the corresponding tone is selected.

With simultaneous connection of the positive voltage to C1 and C2 the tone "C1+C2" is selected.

The switch S1 on the driver board must be set to "+".

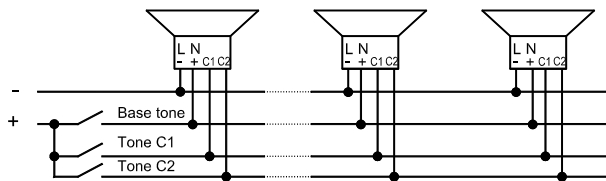
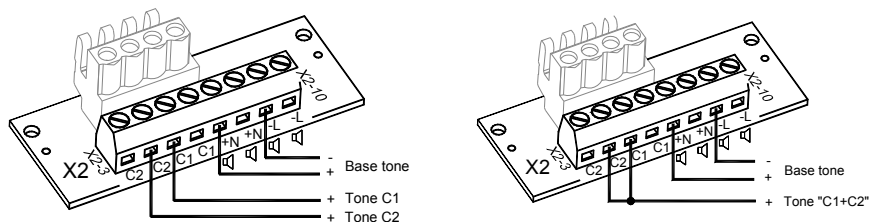

Connection example

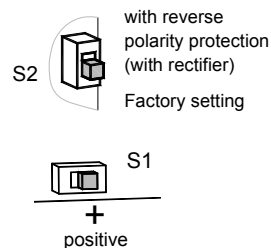

Tone selection through pole reversal (TAR) - for all DC versions except for option -SSM

If the switch S2 on the driver board is in the position "without reverse polarity protection = without rectifier", the tone "C1+C2" can be selected in addition to the base tone through pole reversal. The switch S1 must be set to "+". The control inputs C1 and C2 may not be switched on the circuit board.

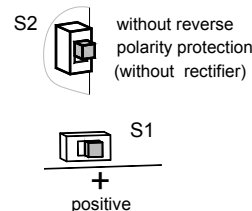
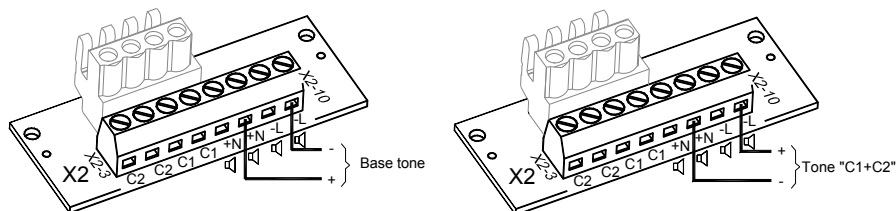

Maintenance, Service and Ordering Spare Parts

The device does not require any special maintenance.

External cleaning should be done with a mild soap solution without the use of solvents.

The device may only be operated in the undamaged state within the specified rating.

Conversions, alterations, improper and inadmissible use as well as the non-observance of the notes in these operating instructions shall render the warranty null and void.

Components may be replaced only by original spare parts.

As a matter of principle, repairs are to be carried out in the manufacturing works.

COOL AIR

INCORPORATED

Ammonia Leak Detection Systems

1544 134th Avenue NE
Ham Lake, Minnesota 55304
763-205-0844
sales@coolairinc.com
www.coolairinc.com

Appendix

„Tone table“ and „Selection of the tones“

Tone table

Grund-Ton-Nr. (♫)	Description		
1	Silence		
2*	Saw tooth, Germany DIN 33404-3 (emergency signal), PFEER PTAP	1200Hz 500Hz	1s EN54-3
9	Slow whoop, fire alarm, UK BS5839-1	970Hz 800Hz	1s
11	Whoop (fast)	970Hz 800Hz	20ms
13	Whoop	900Hz 700Hz	0,3s 0,6s
15	Slow whoop, evacuation, Netherlands NEN 2575	1200Hz 500Hz	3,5s 0,5s EN54-3
16	Slow whoop, evacuation Australia AS2220	1200Hz 500Hz	3,75s 0,25s
18	Slow whoop, NFPA	775Hz 422Hz	0,85s 1s
22	Whoop, Australia AS1670, ISO8201	1200Hz 500Hz	0,5s 0,5s 1,5s
23	Siren	2400Hz 500Hz	3s const.
24	Siren	1200Hz 300Hz	3s const.
25	Siren	800Hz 300Hz	3s const.
26	Industrial alarm (Germany)	1000Hz 150Hz	10s 40s 10s
27	Sweeping	2900Hz 2400Hz	0,5s 0,5s
29	Sweeping (fast)	2900Hz 2400Hz	10ms 10ms
30	Sweeping	2900Hz 2400Hz	70ms 70ms
31	Sweeping, France NF C 48-265	1600Hz 1400Hz	1s 0,5s
33	Sweeping, UK BS5839-1 (medium sweep)	1000Hz 800Hz	0,5s 0,5s
34	Sweeping (fast)	1000Hz 800Hz	10ms 10ms
35	Sweeping, UK BS5839-1 (fast sweep)	1000Hz 800Hz	70ms 70ms
36	Sweeping	1500Hz 700Hz	1,5s 1,5s
43	Sweeping	1200Hz 500Hz	1,5s 1,5s
44	Sweeping, IMO 3d, Germany KTA3901 evacuation	1200Hz 500Hz	1s 1s
45	Sweeping	1200Hz 500Hz	3s 3s
46	Sweeping, Finland General Alarm	1500Hz 500Hz	7s 7s
52	Continuous	2400Hz	— —
53	Continuous	2000Hz	— —

(♫)	Description	
54	Continuous, Finland All Clear	1500Hz — —
55	Continuous	1200Hz — —
56	Continuous, PFEER (Gasalarm)	1000Hz — —
57	Continuous, UK BS5839-1	950Hz — —
59	Continuous	880Hz — —
60	Continuous	825Hz — —
61	Continuous	800Hz — —
63	Continuous	725Hz — —
65	Continuous, Sweden SS031711 (All Clear)	660Hz — —
66	Continuous	554Hz — —
67	Continuous, Germany KTA3901 (All Clear)	500Hz — —
68	Continuous	470Hz — —
69	Continuous	440Hz — —
71	Continuous	340Hz — —
77	Intermittent	2400Hz 0,5s 0,5s
82	Intermittent, PFEER (General Alarm), UK BS5839-1 (Backup Alarm)	1000Hz 0,5s 0,5s
83	Intermittent, PFEER (General Alarm)	1000Hz 1s 1s
88	Intermittent	950Hz 1s 1s
90	Intermittent	825Hz 0,5s 0,5s
91	Intermittent	800Hz 0,25s 0,25s
92	Intermittent	800Hz 0,25s 1s
93	Intermittent (fast), electromechanical horn	800Hz 4rms 4rms
97	Intermittent	725Hz 0,7s 0,3s
98	Intermittent, Sweden SS 031711 (Imminent Danger)	700Hz 0,125s 0,125s
100	Intermittent, Industrial Alarm (Germany)	680Hz 0,875s 0,875s
101	Intermittent, Sweden SS031711 (Important Message (Pre Mess))	660Hz 6,5s 13s
102	Intermittent, Sweden SS031711 (Local Warning)	660Hz 0,5s 0,5s
103	Intermittent, Sweden SS031711 (Air Raid)	660Hz 1,8s 1,8s
104	Intermittent, Sweden SS031711 (Imminent Danger)	660Hz 150ms 150ms
107	Intermittent, Germany KTA3901 (evacuation)	500Hz 0,25s 0,75s
109	Intermittent, Australia AS2220, AS1610, AS1670	420Hz 0,625s 0,625s
110	Intermittent (fast variable), Bell	1450Hz 0,69ms
111	Intermittent, ISO8201 (emergency evacuation signal), USA (evacuation)	470Hz 0,5s 0,5s 1,5s
112	Intermittent, ISO8201 (emergency evacuation signal)	950Hz 0,5s 0,5s 1,5s
113	Intermittent, ISO8201 (emergency evacuation signal) treble tone	2850Hz 0,5s 0,5s 1,5s

Grund-Ton-Nr. (J)	Description	
115	Intermittent, IMO (Telephone Call)	950Hz
116	Intermittent, IMO (abandon ship)	950Hz
117	Intermittent, IMO SOLAS III/50 + SOLAS III/6.4 (General Alarm)	825Hz
122	Alternating	2900Hz 2400Hz
123	Alternating	2900Hz 2400Hz
124	Alternating, Singapore	2000Hz 1000Hz
125	Alternating	1400Hz 1200Hz
128	Alternating	1025Hz 825Hz
130	Alternating, UK BS5839-1 (Fire Alarm)	1000Hz 800Hz
131	Alternating, UK BS5839-1 (Fire Alarm, Level crossing)	1000Hz 800Hz
135	Alternating, UK BS5839-1 (Fire Alarm, increased urgency Level crossing)	1000Hz 800Hz
142	Alternating	900Hz 500Hz
143	Alternating, Germany Industrial Alarm	660Hz 440Hz
144	Alternating	650Hz 440Hz
146	Alternating, France NFS 32-001 (fire alarm)	554Hz 440Hz
147	Alternating, Sweden SS031711 (turn out)	554Hz 440Hz
148	Alternating, Sweden SS031711 (turn out)	554Hz 440Hz
152	Alternating-intermittent	800Hz 650Hz

Selector –switch (Adjusting the base tone)							External Tone Control		
1	2	3	4	5	6	Grund-Ton No. (J)	Tone No.	Tone No.	Tone No.
							C1	C2	C1+C2
ON		ON	ON			27	123	52	92
	ON	ON	ON			29	35	52	61
ON	ON	ON	ON			30	27	52	77
				ON		31	131	52	57
ON				ON		33	30	52	35
	ON			ON		34	35	52	93
ON	ON			ON		35	27	52	110
		ON		ON		36	146	67	57
ON		ON		ON		43	131	52	91
	ON	ON		ON		45	2	57	93
ON	ON	ON		ON		52	15	65	82
			ON	ON		54	46	54	131
ON			ON	ON		55	131	52	128
	ON		ON	ON		56	82	35	33
ON	ON		ON	ON		59	143	59	101
		ON	ON	ON		60	131	52	125
ON		ON	ON	ON		65	131	52	93
	ON	ON	ON	ON		66	110	52	107
ON	ON	ON	ON	ON		69	131	52	110
				ON		71	131	52	93
ON				ON		77	61	52	122
	ON			ON		82	131	52	83
ON	ON			ON		83	56	2	82
		ON		ON		88	2	57	128
ON		ON		ON		90	131	52	125
	ON	ON		ON		91	30	52	110
ON	ON	ON		ON		92	33	52	57
			ON	ON		93	2	128	57
ON			ON	ON		97	2	63	93
	ON		ON	ON		100	131	52	125
ON	ON		ON	ON		101	98	102	65
		ON	ON	ON		103	131	65	147
ON		ON	ON	ON		104	103	65	101
	ON	ON	ON	ON		109	16	52	22
ON	ON	ON	ON	ON		110	131	61	91
				ON	ON	112	2	57	128
ON				ON	ON	113	52	123	104
	ON			ON	ON	115	117	116	44
ON	ON			ON	ON	116	117	93	125
		ON		ON	ON	117	93	116	125
ON		ON		ON	ON	123	27	52	77
	ON	ON		ON	ON	124	53	83	2
ON	ON	ON		ON	ON	130	2	107	67
			ON	ON	ON	131	2	112	57
ON			ON	ON	ON	135	16	56	109
	ON		ON	ON	ON	142	2	54	88
ON	ON		ON	ON	ON	143	59	93	33
		ON	ON	ON	ON	144	110	61	2
ON		ON	ON	ON	ON	146	31	67	57
	ON	ON	ON	ON	ON	148	131	52	92
ON	ON	ON	ON	ON	ON	152	110	61	13

* Factory setting

Selection of the tones

Selector –switch (Adjusting the base tone)							External Tone Control		
1	2	3	4	5	6	Grund-Ton No. (J)	Tone No.	Tone No.	Tone No.
							C1	C2	C1+C2
						1	2	88	57
ON						2 *	128	112	57
	ON					2	26	100	93
ON	ON					2	61	131	112
		ON				9	57	11	82
ON		ON				15	131	52	112
	ON	ON				16	109	52	56
ON	ON	ON				18	111	57	68
			ON			22	16	109	68
ON			ON			23	131	52	112
	ON		ON			24	131	52	131
ON	ON		ON			25	131	52	92
		ON	ON			26	2	100	93